

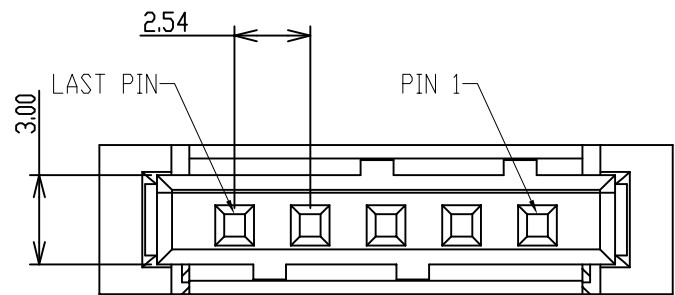

RoHS

REV.	ECR	DESCRIPTION	DATE	REVISDR	CHECKED	APPROVED
A		NEW RELEASE		WDD	LW	WF
B		Description PIN order	2021/12/27	JACK	MANGER	LYG

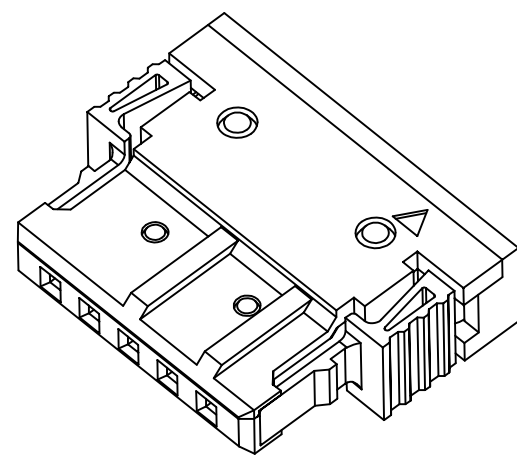
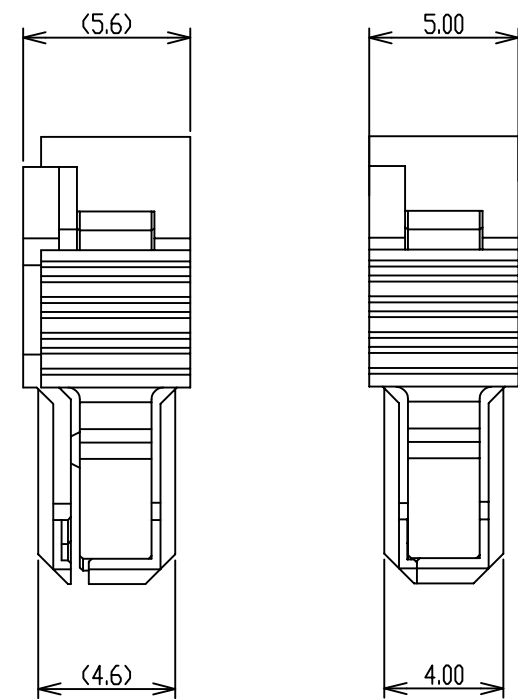
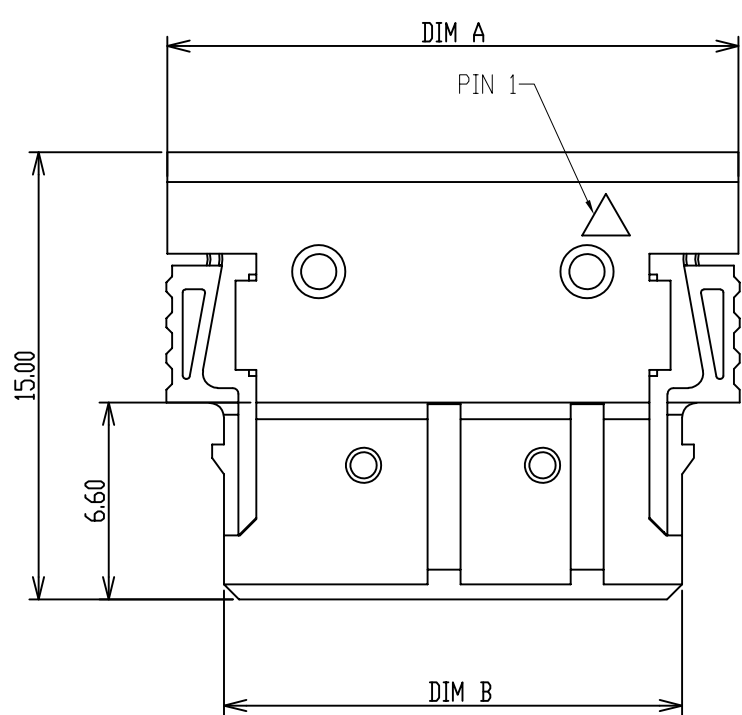

ITEM	DIM A	DIM B
2 PIN	11.54	7.74
3 PIN	14.08	10.28
4 PIN	16.62	12.82
5 PIN	19.16	15.36
6 PIN	21.70	17.90
8 PIN	26.78	22.98

DRAWN	DATE	GENERAL X. ±0.38 .X ±0.25 .XX ±0.13 .XXX ±0.05	ANGLES X° ±3.0° .X° ±2.0° .XX° ±1.0°	 YXT 益鑫通精密电子有限公司 YXT Precision Electronics Co.,Ltd.
JACK	2021/12/27			
DESIGN	DATE	GENERAL TOLERANCES UNLESS OTHERWISE SPECIFIED		TITLE
MANGER	2021/12/27			Pitch 2.54mm Single Row WTB Connector
CHECKED	DATE	 UNIT: mm		SIZE A4
MANGER	2021/12/27			P/N
APPROVED	DATE	SHEET 1 OF 3		WTB10-WQXXHB00
LYG	2021/12/27			SCALE 4:1
CUSTOMER DRAWING		SCALE 4:1		REV. B
				DWG NO. C-WTB10-1W-00

RoHS

PRODUCT NUMBER CODE

WTB10 - W 0 XX H B 00
 ① ② ③ ④ ⑤ ⑥ ⑦

- ① PRODUCT:
WTB10 : 2.54mm PITCH SINGLE ROW WTB CONNECTOR
- ② TYPE 1:
W:WIRE
- ③ TYPE 2:
0: SINGLE ROW
- ④ PRODUCT
XX: XX POSITIONS
- ⑤ PRODUCT
H: HORIZONTAL
- ⑥ COLOR
B: BLACK
- ⑦ OTHERS:

1. MATERIAL



- 1.1 INSULATOR: HIGHT TEMPERATURE PLASTIC, UL94V-0, BLACK COLOR.
- 1.2 CONTACT: COPPER ALLOY, GOLD PLATED<SEE ORDER INFORMATION>
IN CONTACT AREA, MATTE-TIN PLATED IN SOLDER AREA, NICKEL UNDERPLATED OVERALL.
- 1.3 LATCH: COPPER ALLOY, TIN PLATED, NICKEL UNDERPLATED OVERALL.

2. SPECIFICATIONS:

- 2.1 CURRENT RATING:4A MAX DEPENDS ON THE CABLE.
- 2.2 WITHSTANDING VOLTAGE: 500V AC FOR A MINUTE.
- 2.3 INSULATION RESISTANCE: 100M OHMS MIN. DC 500V.
- 2.4 CONTACT RESISTANCE: 10mΩ MAX.
- 2.5 OPERATING TEMPERATURE: -40°C ~ +125°C.

3. APPLICATION:

- 3.1 MATES WITH WIRE CONNECTOR:
WTB10-BOXXHBX0<DOCUMENT NO:C-WTB10-1P-01>.
WTB10-BOXXVBX0<DOCUMENT NO:C-WTB10-1P-00>

DRAWN	DATE	GENERAL X. ±0.38 .X ±0.25 .XX ±0.13 .XXX ±0.05	ANGLES X° ±3.0° .X° ±2.0° .XX° ±1.0°	 益鑫通精密电子有限公司 YXT Precision Electronics Co.,Ltd.	
JACK	2021/12/27				
DESIGN	DATE	GENERAL TOLERANCES UNLESS OTHERWISE SPECIFIED		TITLE Pitch 2.54mm Single Row WTB Connector	
MANGER	2021/12/27				
CHECKED	DATE	 UNIT: mm		SIZE	A4
MANGER	2021/12/27			P/N	WTB10-W0XXHB00
APPROVED	DATE	CUSTOMER DRAWING	SHEET 2 OF 3	SCALE	1:1
LYG	2021/12/27	REV.	B	DWG	NO. C-WTB10-1W-00

RoHS

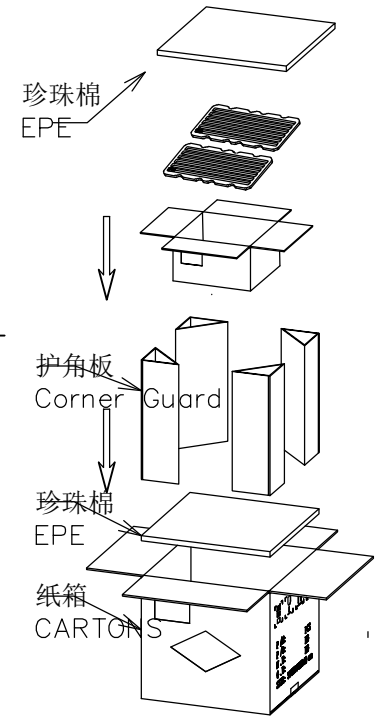
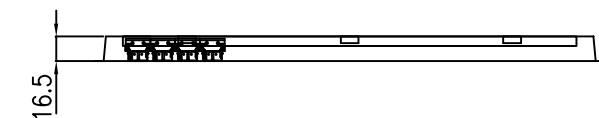
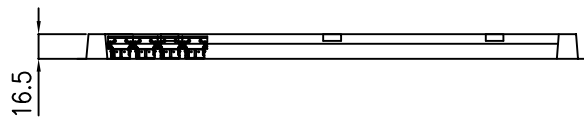
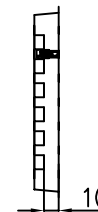
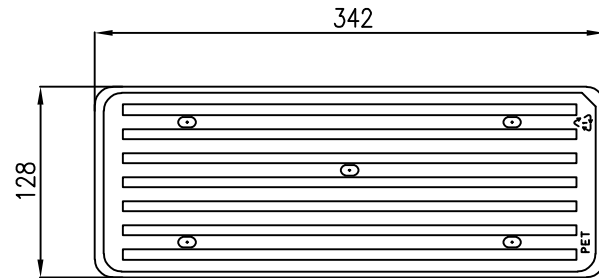
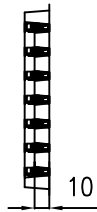
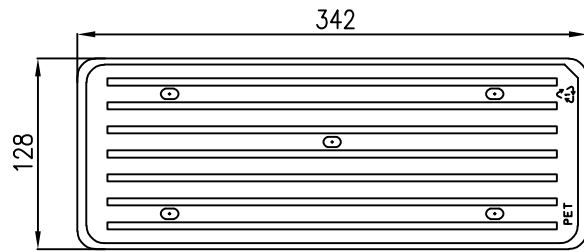

备注：

1. 中箱包装尺寸为 364mm*280mm*90mm
2. 外箱包装尺寸为 370mm*370mm*340mm
3. 单个外箱放3个中箱，四周用泡棉防护

产品料号	包装数/TRAY	包装数/外箱
WTB10-W002HB00	182	1820
WTB10-W003HB00	147	1470
WTB10-W004HB00	126	1260
WTB10-W005HB00	105	1050
WTB10-W006HB00	91	910
WTB10-W008HB00	77	770

DRAWN	DATE	GENERAL	ANGLES	YXT 益鑫通精密电子有限公司 YXT Precision Electronics Co., Ltd.
JACK	2021/12/27	X. ±0.38	X°. ±3.0°	
DESIGN	DATE	.X ±0.25	.X° ±2.0°	TITLE
MANGER	2021/12/27	.XX ±0.13	.XX° ±1.0°	
CHECKED	DATE	.XXX ±0.05		Pitch 2.54mm Single Row WTB Connector
MANGER	2021/12/27	GENERAL TOLERANCES UNLESS OTHERWISE SPECIFIED		
APPROVED	DATE			SIZE A4
LYG	2021/12/27	UNIT: mm		P/N WTB10-W00XHB00
CUSTOMER DRAWING	SHEET 3 OF 3	SCALE 1:1	REV. B	DWG NO. C-WTB10-1W-00