

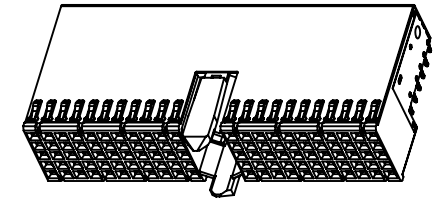

REV.	ECR	DESCRIPTION	DATE	REVISOR	CHECKED	APPROVED
A	TJECR19024	NEW RELEASE	2018/04/09	Seven.Yuan	Jason.Bian	Dickson.Guan
B	NTECR20001		2018/04/09	Xiang.Chen	Seven.Yuan	Jason.Bian
C	ECR20014	CHANGE OF COMPANY NAME	2020/09/22	Lucien.Lu	Seven.Yuan	Jimmy.Ni

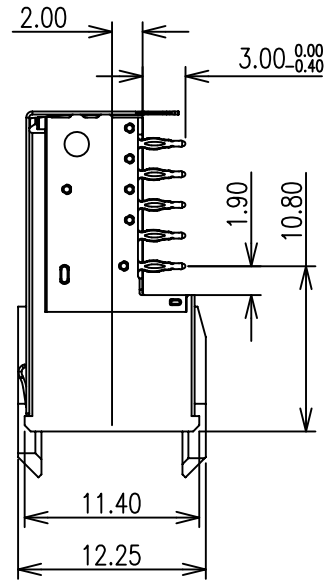

DRAWN Seven.Yuan	DATE 2020/05/22	GENERAL X. ±0.38 .X ±0.25 .XX ±0.20 .XXX ±0.05	ANGLES X' ±3.0° .X' ±2.0° .XX' ±1.0°	 益鑫通精密电子有限公司 YXT Precision Electronics Co.,Ltd.
DESIGN Seven.Yuan	DATE 2020/05/22	GENERAL TOLERANCES UNLESS OTHERWISE SPECIFIED		
CHECKED Jason.Bian	DATE 2020/05/22	UNIT: mm		TITLE 2mm HARD METRIC FEMALE TYPE A 110 Pin CONNECTOR
APPROVED Dickson.Guan	DATE 2020/05/22		SCALE 2:1	SIZE A4 P/N YXT-HMC-FA1100-01
CUSTOMER DRAWING	SHEET 1 OF 2	SCALE 2:1	REV. C	DWG NO. C-HMC-5S-04

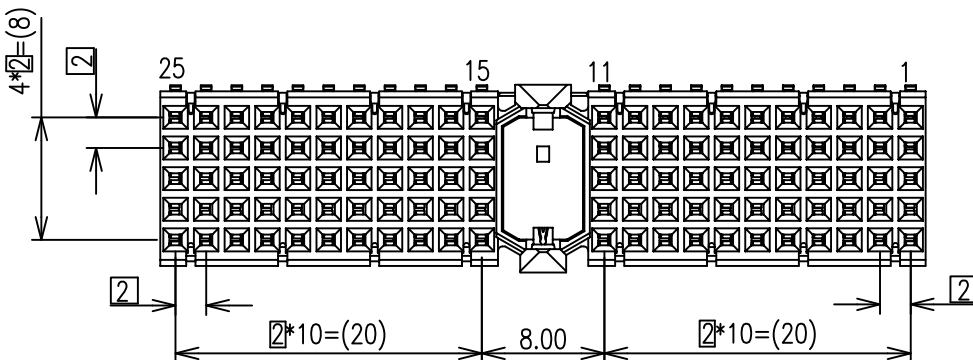
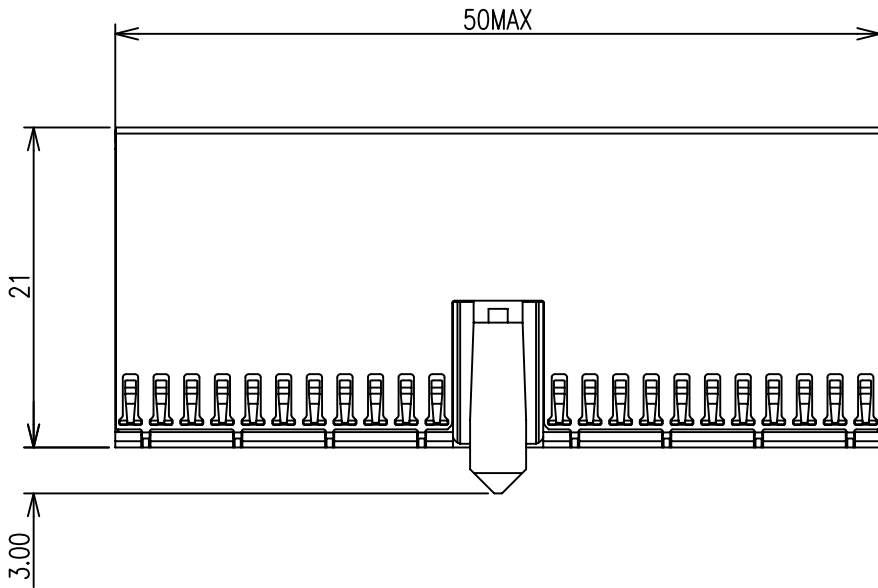
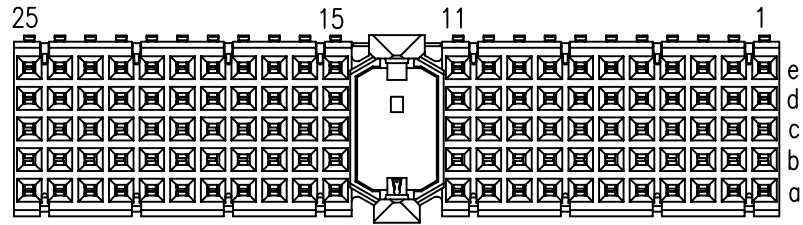

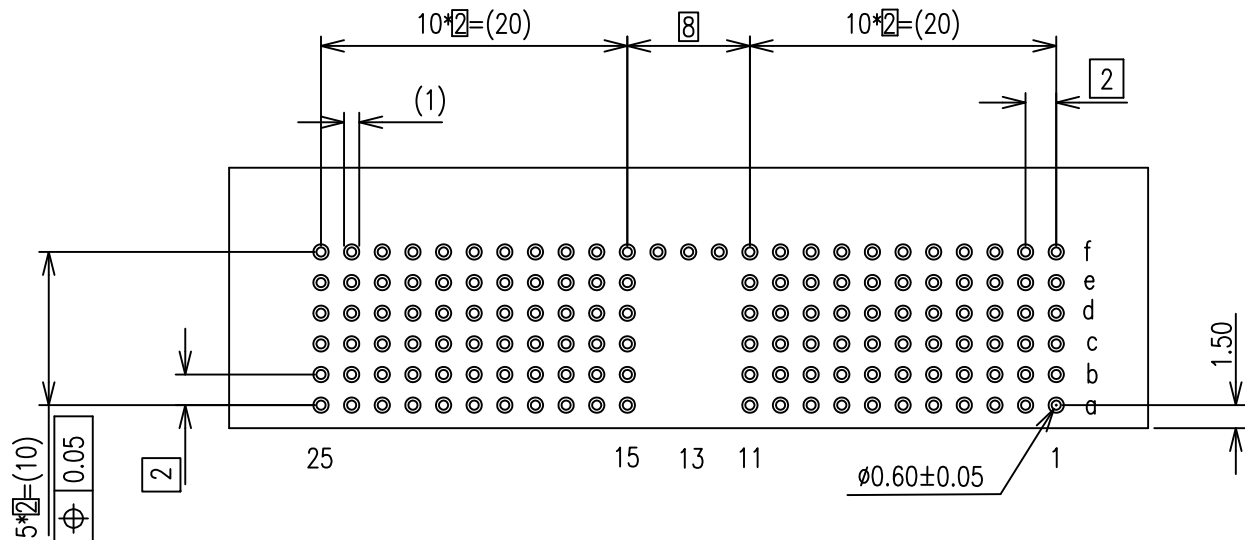
YXT-HMC- FA 110 0 - 0 1  
 1 2 3 4

- 1.TYPE  
FA:FEMALE TYPE A
- 2.POSITIONS  
110: 110 PINS
- 3.POST  
0:WITHOUT POST
- 4.SHIELD  
1:WITH SHIELD

NOTES:

- 1.0:RATING:
- 1.1:VOLTAGE:500V AC/DC
- 1.2:CURRENT:1.5 AMPS
- 1.3:OPERATION TEMPERATURE:-55°C TO +125°C
- 1.4:CONNECTOR PITCH:2MM
- 1.5:PERFORMANCE LEVEL:≥250 MATING CYCLES
- 1.6:PRESSFIT PIN INSERTION:0.6MM±0.05MM AFTER PLATING
- 1.7:FLAMMABILITY:UL94V-0

DRAWN Seven.Yuan	DATE 2020/05/22	GENERAL X. ±0.38 .X ±0.25 .XX ±0.20 .XXX ±0.05	ANGLES X' ±3.0' .X' ±2.0' .XX' ±1.0'	益鑫通精密电子有限公司 YXT Precision Electronics Co.,Ltd.
DESIGN Seven.Yuan	DATE 2020/05/22	GENERAL TOLERANCES UNLESS OTHERWISE SPECIFIDE		
CHECKED Jason.Bian	DATE 2020/05/22	APPROVED Dickson.Guan	DATE 2020/05/22	UNIT: mm
CUSTOMER DRAWING	SHEET 2 OF 2	SCALE 2:1	REV. C	SIZE A4 P/N YXT-HMC-FA1100-01 DWG NO. C-HMC-5S-04