

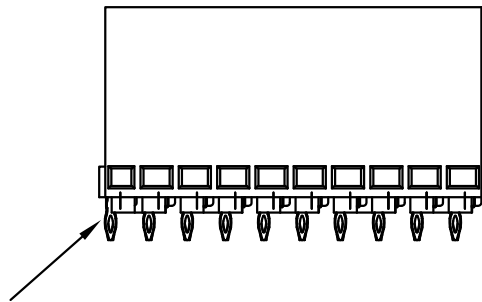

REV.	ECR	DESCRIPTION	DATE	REVISOR	CHECKED	APPROVED
A	TJECR18011	NEW RELEASE	2018/06/21	Jim.Wang	Jason.Bian	Dickson.Guan
B	NTECR20002	NEW RELEASE	2020/05/06	Xiang.Chen	Seven.Yuan	Dickson.Guan
C	ECR20014	CHANGE OF COMPANY NAME	2020/09/22	Lucien.Lu	Seven.Yuan	Jimmy.Ni

	B端子	D端子
DIM A	1.7	3.7

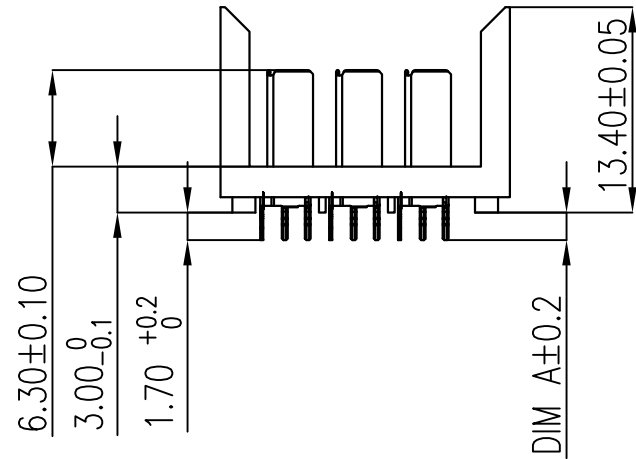

compliant zone for through hole
 $\phi 0.6 \pm 0.05$



DRAWN Jim.Wang	DATE 2018/06/21	GENERAL X. ±0.38 .X ±0.25 .XX ±0.20 .XXX ±0.05	ANGLES X° ±3.0° .X° ±2.0° .XX° ±1.0°	 YXT 益鑫通精密电子有限公司 YXT Precision Electronics Co.,Ltd.
DESIGN Jim.Wang	DATE 2018/06/21	GENERAL TOLERANCES UNLESS OTHERWISE SPECIFIED		
CHECKED Jason.Bian	DATE 2018/06/21	UNLESS OTHERWISE SPECIFIED		TITLE ZD CONNECTOR 3-10
APPROVED Dickson.Guan	DATE 2018/06/21	UNIT: mm	SIZE A4	P/N YXT-ZDC-MV060X-01
CUSTOMER DRAWING	SHEET 1 OF 2	SCALE 2:1	REV. C	DWG NO. C-ZDC-3P-00

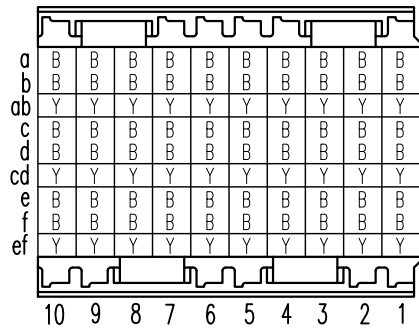

CONTACT LAYOUT

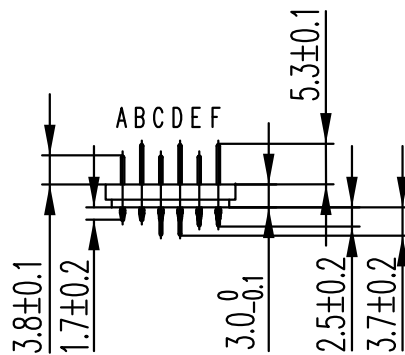

Contact selection options, male contacts

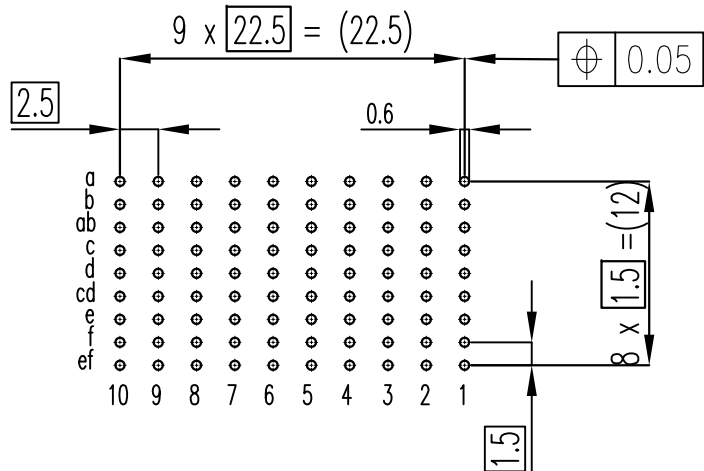

PCB LAYOUT

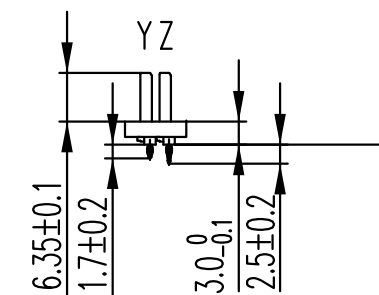

Contact selection options, shielding contacts

YXT-ZDC - M V 060 X-0 1
1 2 3 4 5 6 7

1.PRODUCT
ZD CONNECTOR

2.TYPE
M:MALE

3.PRODUCT
V:VERTICAL

4.POSITIONS
060:60 POSITIONS

5.TERMINAL
B:B TERMINAL
D:D TERMINAL

6.POST
O:WITHOUT POST

7.SHIELD
1:WITH SHIELD Y

DRAWN Jim.Wang	DATE 2018/06/21	GENERAL X. ±0.38 .X ±0.25 .XX ±0.20 .XXX ±0.05	ANGLES X' ±3.0' .X' ±2.0' .XX' ±1.0'	 益鑫通精密电子有限公司 YXT Precision Electronics Co.,Ltd.	
DESIGN Jim.Wang	DATE 2018/06/21	GENERAL TOLERANCES UNLESS OTHERWISE SPECIFIED			TITLE ZD CONNECTOR 3-10
CHECKED Jason.Bian	DATE 2018/06/21	UNIT: mm	SIZE A4	P/N YXT-ZDC-MV060X-01	
APPROVED Dickson.Guan	DATE 2018/06/21	SCALE 2:1	REV. C	DWG NO. C-ZDC-3P-00	
CUSTOMER DRAWING		SHEET 2 OF 2			